

REFRIGERATOR MANUFACTURER  
**Turbo air**

*Turbo Air Speeds up the Pace of Innovation*

# Open Display Merchandisers Installation and Operation Manual

Please read this manual completely before attempting to install or operate this equipment.

## *Horizontal Open Display Cases*

TOM-30L\*-\*-\*-N

TOM-40L\*-\*-\*-N

TOM-50L\*-\*-\*-N

TOM-60L\*-\*-\*-N

TOM-75L\*-\*-\*-N

TOM-30S\*-\*-\*-N

TOM-40S\*-\*-\*-N

TOM-50S\*-\*-\*-N

TOM-60S\*-\*-\*-N

TOM-75S\*-\*-\*-N

TOM-W-30S\*-\*-\*-N

TOM-W-40S\*-\*-\*-N

TOM-W-50S\*-\*-\*-N

TOM-W-60S\*-\*-\*-N

TOM-W-75S\*-\*-\*-N

TOM-W-30S\*-\*-\*-UF-N

TOM-W-40S\*-\*-\*-UF-N

TOM-W-50S\*-\*-\*-UF-N

TOM-W-60S\*-\*-\*-UF-N

TOM-W-75S\*-\*-\*-UF-N

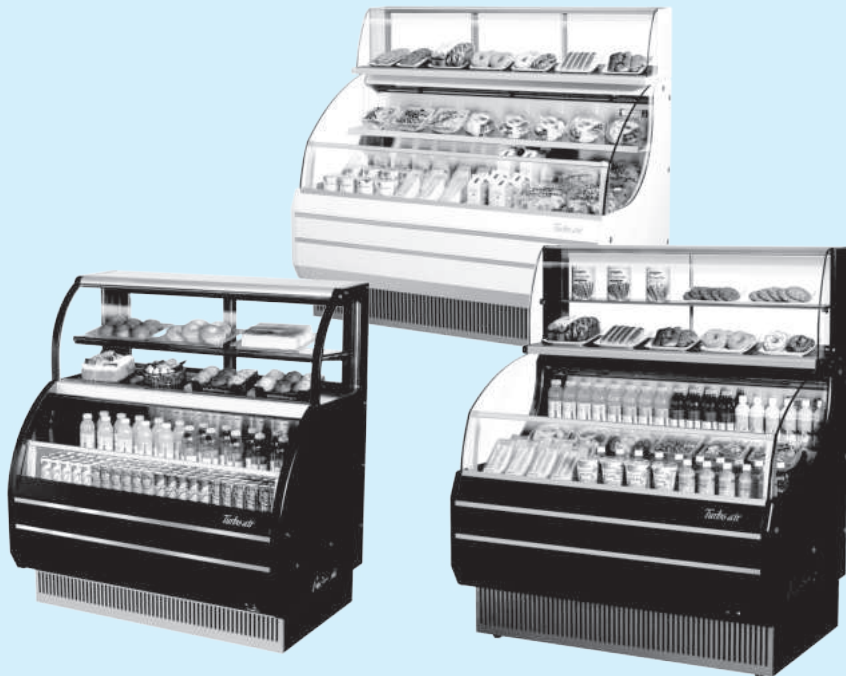

# CONTENTS

	PAGE
<b>INTRODUCTION</b> .....	10
<b>SPECIFICATIONS</b> .....	11
<b>INSTALLATION</b> .....	12
Damage inspection	
Location of display	
Leveling of display	
<b>OPERATING INSTRUCTIONS</b> .....	14
Power switch	
Light switch	
Temperature control	
Thermometer	
Placing the product	
<b>MAINTENANCE &amp; CLEANING</b> .....	15
Condenser coil	
<b>TROUBLESHOOTING</b> .....	16
Merchandiser not functioning	
Merchandiser is warm	
Lights are not working	
<b>WARRANTY</b> .....	17
<b>NOTE</b> .....	19~22

## NOTICE

- This equipment is not intended for use by persons (including children) with reduced physical, sensory or mental capabilities, or lack of experience and knowledge unless they have been given supervision or instructions concerning the use of this equipment and the hazards involved by a person responsible for their safety.
- Special instructions for those persons (including children) with reduced physical, sensory or mental capabilities, or lack of experience and knowledge, are not included in this manual and are not required to be included.
- Children shall not play with the appliance.
- Cleaning and user maintenance shall not be made by children without supervision.

This manual uses the following safety symbols. These safety symbols with the words of **DANGER**, **WARNING** or **CAUTION** alert users of the potential hazards that could cause injury or even death.



Indicates hazards of death or serious injury, if the instructions are not followed.



Indicates dangers of death or serious injury, if the instructions are not followed.









Indicates risks of personal injury or material damage, if the instructions are not followed.

## FOR HYDROCARBON REFRIGERATION UNITS

### **WARNING**

This unit uses R-290 (propane), or R-600a (isobutane) as a refrigerant. These hydrocarbon refrigerants are highly environmentally compatible but also are flammable and combustible. Please read this manual thoroughly before installing and operating the unit. Please take cautious measures to avoid risk of fire or explosion.

**PLEASE REFER TO THE LABEL INSIDE THE CABINET TO CHECK REFRIGERATION TYPE AND VOLUME.**

	<b>DANGER</b> - Risk of fire or explosion. Flammable refrigerant used. Do not use mechanical devices to defrost refrigerator. Do not puncture refrigerant tubing.
	<b>DANGER</b> - Risk of fire or explosion. Flammable refrigerant used. To be repaired only by trained service personnel. Do not puncture refrigerant tubing.
	<b>CAUTION</b> - Risk of fire or explosion. Dispose of properly in accordance with federal or local regulations. Flammable refrigerant used.
	<b>CAUTION</b> - Risk of fire or explosion. Flammable refrigerant used. Consult repair manual/owner's guide before attempting to service this product. All safety precautions must be followed.
	<b>CAUTION</b> - Risk of fire or explosion due to puncture of refrigerant tubing; follow handling instructions carefully. Flammable refrigerant used.
	<p><b>WARNING</b></p> <ul style="list-style-type: none"> <li>- Keep ventilation openings in the appliance enclosure or in the built-in structure, clear of obstruction.</li> <li>- Do not use mechanical devices or other means to accelerate the defrosting process, other than those recommended by the manufacturer.</li> <li>- Do not damage the refrigerant circuit.</li> <li>- Do not use electrical appliances inside the food storage compartments of the appliance unless they are of a type recommended by the manufacturer.</li> </ul>

## FOR HYDROCARBON REFRIGERATION UNITS

### **WARNING**

- Handle the unit with care in order to avoid any serious damage to the refrigeration system.
- The refrigerant tubing, condenser, and evaporator coils are easily prone to damage while handling, moving, installing, and cleaning the unit, which may lead to fire or even explosion.
- Refrigerant squirting out of the pipes could ignite or cause an eye injury. If a leak is detected, avoid any naked flames or potential sources of ignition and air the room in which the appliance is standing for several minutes.
- In order to avoid the creation of a flammable gas-air mixture in case of a leak in the refrigerating circuit, the size of the room in which the appliance is placed depends on the amount of refrigerant used. The room must be 35.31ft<sup>3</sup> 1 m<sup>3</sup> in size for every 0.28oz (8g) of R-290 refrigerant inside the appliance. The amount of refrigerant in your particular appliance is shown on the label inside the cabinet.



This appliance contains a small amount of propane (R-290) or isobutane (R-600a) refrigerant, a natural gas with high environmental compatibility, but which is also combustible. When transporting and installing the appliance, care should be taken to ensure that no part of the refrigerating circuit is damaged.

- Never start up an appliance showing any signs of damage. If in doubt, contact a qualified service professional.
- In case of any hazardous activities such as fire or explosion, move the unit away from any source of ignition to a well ventilated area.
- Further service and repair must be done by a qualified technician who is familiar with the safety standards, and also has thorough understanding and knowledge of the flammable refrigerants.
- Any and all technicians handling these units must be equipped with proper personal protection and equipment and follow applicable safety measures and precautions to avoid risk of fire or explosion.

## IMPORTANT SAFETY INFORMATION

### **SAFETY PRECAUTIONS**

To avoid any risk of fire, explosion, electric shock, personal injury, material damage or incorrect use of the appliance, be sure to observe the following safety precautions. (After reading these owner's manual instructions, please keep the manual booklet in a safe place for reference. Remember to hand it over to any subsequent owners)

### **WARNING**

- The unit must be installed and located in accordance with the manufacturer's installation instructions.
- Installation work must be performed in accordance with the National Electric Code by qualified and authorized personnel only.
- Repairs and replacement work must be performed by a qualified and authorized service professional only using genuine replacement parts.
- Do not use an extension cord or an adapter plug. Because of the potential safety hazards under certain conditions, we strongly recommend against any use of an extension cord or an adapter plug.
- Do not, under any circumstances, cut or remove the ground prong from the power cord. For personal safety, this appliance must be properly grounded.
- Do not store volatile and flammable substances in the refrigerator. The storage of benzene, thinner, alcohol, ether, LP gas, or other explosive substances may cause an explosion.
- Do not store or use gasoline or other flammable vapors and liquids in the vicinity of this appliance as well as any other appliances.
- The appliance is not intended for use by children without supervision.
- Do not allow children to climb, stand, or hang on the refrigerator doors or shelves in the refrigerators. They could damage the refrigerator and seriously injure themselves.
- To prevent suffocation and entrapment hazards to children, remove the doors and seals from the refrigerator before disposing of it or discontinuing its use.

## IMPORTANT SAFETY INFORMATION

### **INSTALLATION & USAGE**

#### **WARNING**

- Do not install the unit in a damp place where it could be splashed with water. Incorrect insulation of the electrical parts may cause fire or electric shock.
- Do not plug several appliances into the same sockets. This could cause overheating and risk start of a fire.
- Keep the power plug away from the rear of the cabinet. A damaged power plug may cause fire due to overheating.
- Do not spray water directly to the interior or exterior of the appliance. There is a risk of fire or electric shock.
- Do not place any containers filled with water on top of the appliance. If the water spills onto any electrical parts, it may lead to fire or electric shock.
- Do not attempt to repair, disassemble or alter the appliance. It may cause fire or abnormal operations which may lead to injury.
- Unplug the refrigerator before making repairs, replacing a light bulb, or cleaning.
- Plug into a grounded 3-prong outlet. Do not remove the ground prong.

#### **CAUTION**

- Do not store too much food in the appliance. When you open the door, an item may fall out and cause personal injury or material damage.
- Do not put bottles or any kind of glass in the freezer. The container may break and cause personal injury.
- Do not disconnect the power cord by pulling on it. This may disconnect a wire and cause a short circuit.

## IMPORTANT SAFETY INFORMATION

### INSTALLATION & USAGE

#### CAUTION

- There is a risk of death from suffocation if a child puts the packing materials on his or her head.
- Do not store any articles on top of the appliance. Articles may fall while opening or closing the door, and could cause personal injury or material damage.
- Do not store pharmaceutical products, scientific materials or other temperature-sensitive products in the refrigerator. Products that require strict temperature controls must not be stored in the refrigerator.
- Do not let children hang on the door.
- Do not touch any cold surfaces or food containers in the freezer with damp or wet hands. Skin may stick to these extremely cold surfaces and may cause frostbite.
- Remove any foreign matter from the power plug pins. Otherwise, there is a risk of fire.
- Do not insert your hand into the bottom area of appliance. Any sharp edges may cause personal injury.
- After unplugging the appliance, wait at least five minutes before plugging it back in. Abnormal operation of the freezer may cause material damage.
- If the appliance is not used for a long period of time, unplug it from the power supply. Any deterioration in the insulation may cause fire.
- Do not let children touch or play with the control panel on the front of the appliance.
  - Do not allow children to play with this appliance.
  - Do not stand or lean on the base panel, pull-out parts, or doors.
  - Repairs and maintenance of the appliance should only be performed by a qualified technician. Incorrect repairs done by an unqualified person may be a potential source of danger that could have critical consequences for the user of the appliance.
  - Never put ice cubes or ice pops straight from the freezer into your mouth. The low temperature may cause cold burns.



## IMPORTANT SAFETY INFORMATION

### **PROPER DISPOSAL OF OLD APPLIANCE**

For environmental purposes, refrigeration appliances must be disposed of properly. This applies to your old appliance, and at the end of its service life, for your new appliance as well.

#### **WARNING**

Before disposing of old appliances, make them inoperable. Remove plug from mains, sever the power cable, and remove or destroy any snap or latch closures.

This eliminates the danger of any children locking themselves into the appliance (danger of suffocation) or placing themselves into other life-threatening situations.

- The appliance may not be disposed of with domestic waste or bulky refuse.
- The refrigerant circuit, especially the heat exchanger at the back of the appliance, may not be damaged.
- Information concerning collection schedules or locations can be obtained from the local disposal authorities.

#### **CAUTION**

The refrigeration used in refrigerator/freezer and the gases in the insulation material require special disposal procedures. Ensure that none of the pipes on the back of the appliance are damaged prior to disposal.

### **BEFORE YOU CALL FOR SERVICE**

Before contacting our Service Department, review the detailed troubleshooting tips in the Owner's manual.

1. Try to remedy the problem. Please read the "Troubleshooting Guide" section first and you may not need to call for service.
2. Restart the appliance to check whether the fault repeats. If the malfunction persists, switch off the appliance and try again after an hour.
3. If the malfunction still persists, then contact our Customer Service, specifying:
  - The nature of the problem,
  - The appliance model number and serial number
  - Your full address, telephone number and area code.

## INTRODUCTION

This owner's manual has important information. Please read the entire manual before installing your new Turbo Air Open Display Merchandiser. For specific questions not answered on this manual, please call:

### **CUSTOMER SERVICE DEPARTMENT**

#### **TURBO AIR**

**4184 E. Conant St.  
Long Beach, CA 90808**

**1-800-381-7770**

Please write down the model and serial number of your merchandiser for future references:

**MODEL NUMBER** \_\_\_\_\_

**SERIAL NUMBER** \_\_\_\_\_

## WARNING

Keep this manual in a safe place for your reference.

Failure to read this manual in its entirety can result in misuse of the equipment, which may cause personal injury or equipment failure.

### **WARNING!**

Display Case should be on a minimum 20 Amps dedicated outlet and minimum 12 AWG wire for proper operation.

# SPECIFICATIONS

Model	TOM-30L***-N	TOM-40L***-N	TOM-50L***-N	TOM-60L***-N	TOM-75L***-N
Dimension (W x D x H) in.	28 x 34.6 x 46.1	39 x 34.6 x 46.1	50.8 x 34.6 x 46.1	63.2 x 34.6 x 46.1	75.6 x 34.6 x 46.1
Electricity	115V/1PH/60HZ				
Full Load Amperes	6.7A	6.9A	6.9A	11.3A	11.3A
Compressor	NEK6210U	NEU6217U		2 X NEU6217U	
Refrigerant	R-290				
Lighting	6.3W X 2	9.5W X 2	12.6W X 2	15.8W X 2	18.9W X 2 18.9W X 1
Defrost	Timed off defrost				
Net Weight	257 lbs.	317 lbs.	376 lbs.	448 lbs.	507 lbs.

Model	TOM-30S***-N	TOM-40S***-N	TOM-50S***-N	TOM-60S***-N	TOM-75S***-N
Dimension (W x D x H) in.	28 x 34.6 x 41.7	39 x 34.6 x 41.7	50.8 x 34.6 x 41.7	63.2 x 34.6 x 41.7	75.6 x 34.6 x 41.7
Electricity	115V/1PH/60HZ				
Full Load Amperes	6.7A	6.9A	6.9A	11.3A	11.3A
Compressor	NEK6210U	NEU6217U		2 X NEU6217U	
Refrigerant	R-290				
Lighting	6.3W X 1	9.5W X 1	12.6W X 1	15.8W X 1	18.9W X 1
Defrost	Timed off defrost				
Net Weight	255 lbs.	313 lbs.	370 lbs.	440 lbs.	498 lbs.

Model	TOM-W-30S***-N	TOM-W-40S***-N	TOM-W-50S***-N	TOM-W-60S***-N	TOM-W-75S***-N
Dimension (W x D x H) in.	26.9 x 34 x 56.5	38.9 x 34 x 56.5	50.9 x 34 x 56.5	62.7 x 34 x 56.5	75.2 x 34 x 56.5
Electricity	115V/1PH/60HZ				
Full Load Amperes	6.7A	6.9A	6.9A	11.3A	11.3A
Compressor	NEK6210U	NEU6217U		2 X NEU6217U	
Refrigerant	R-290				
Lighting	5.3W X 3	8.4W X 3	11.6W X 3	14.7W X 3	17.9W X 1 8.4W X 4
Defrost	Timed off defrost				
Net Weight	354 lbs.	425 lbs.	496 lbs.	567 lbs.	638 lbs.

Model	TOM-W-30S***-UF-N	TOM-W-40S***-UF-N	TOM-W-50S***-UF-N	TOM-W-60S***-UF-N	TOM-W-75S***-UF-N
Dimension (W x D x H) in.	26.9 x 34 x 56.5	38.9 x 34 x 56.5	50.9 x 34 x 56.5	62.7 x 34 x 56.5	75.2 x 34 x 56.5
Electricity	115V/1PH/60HZ				
Full Load Amperes	6.7A	6.9A	6.9A	11.3A	11.3A
Compressor	NEK6210U	NEU6217U		2 X NEU6217U	
Refrigerant	R-290				
Lighting	5.3W X 3	8.4W X 3	11.6W X 3	14.7W X 3	17.9W X 1 8.4W X 4
Defrost	Timed off defrost				
Net Weight	354 lbs.	425 lbs.	496 lbs.	567 lbs.	638 lbs.

# INSTALLATION INSTRUCTIONS

## **DAMAGE INSPECTION**

Prior to installation, the customer must check for damages with the freight company before the unit is accepted.

1. If the crate is damaged, make sure to note the damage on the Bill of Lading prior to signing the delivery off.
2. Concealed damage must be reported within 5 days of receiving the unit. Bill of Lading must be faxed to the Claims department. Pictures of both unit and crating may be requested.

## **LOCATION OF OPEN DISPLAY MERCHANDISER**

Open Display Merchandisers are designed to be in an area that is ambient 75 degrees Fahrenheit (dry bulb) or colder with 55 percent relative humidity. If the installed unit is in a warm ambient area, it may not be as effective. Position the Merchandiser at its final location before removing the shipping skid. There are four bolts at the bottom of the merchandiser that secure the shipping skid. Remove all four bolts to remove the skid. Allow three inches of space from the wall to the back of the merchandiser. Condenser is located to the front. Do NOT block inlet.

## **LEVELING THE OPEN DISPLAY MERCHANDISER**

Four leveling legs are provided to level your Merchandiser. Use a leveler to ensure the unit is evenly leveled on all four corners. If the unit is not leveled correctly, excess water buildup will not drain properly. If you do not wish to use the levelers, they can be turned inwards.

## Turbo Air Recommended Operating Conditions

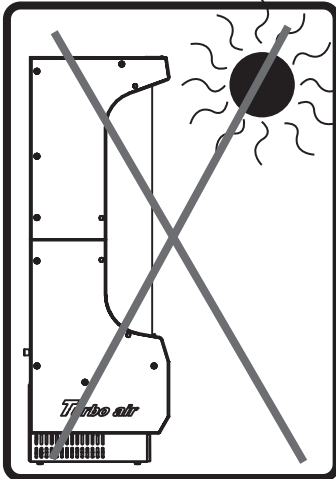

- Units should not be placed in direct sunlight.

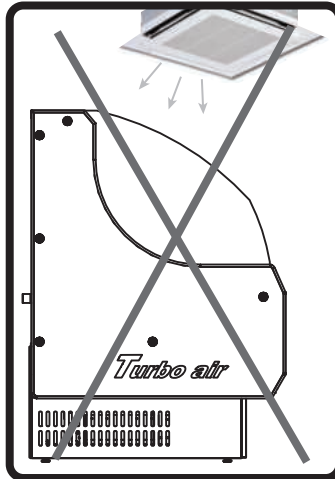

- Units should not be placed near HVAC vents.

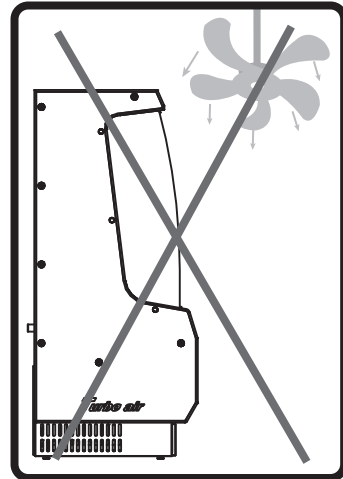

- Units should not be placed near fans.

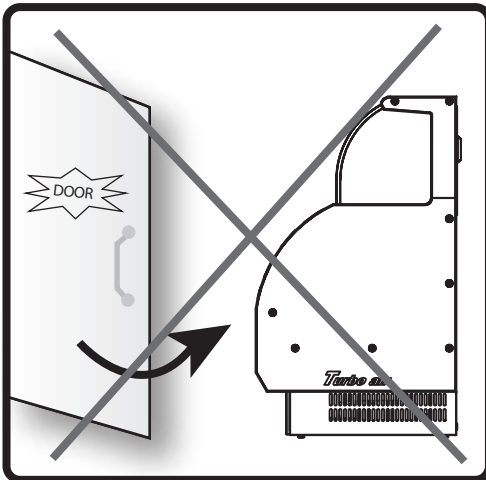

- Units should not be placed near doorways.

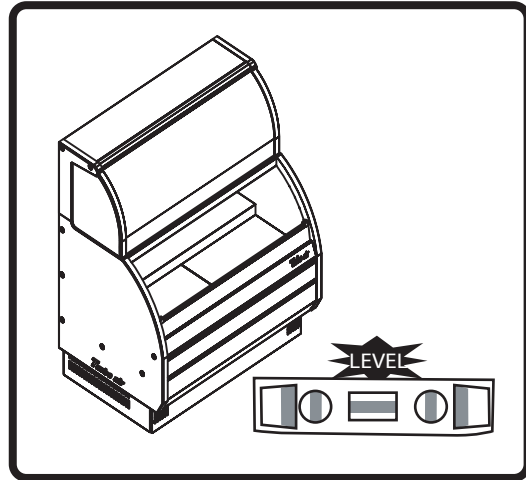

- Level the cabinet on all four corners of the base.

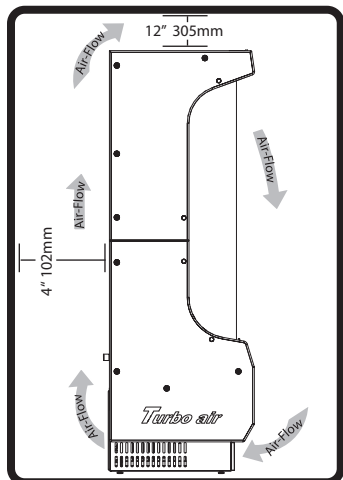

- Confirm there is enough clearance for proper air circulation

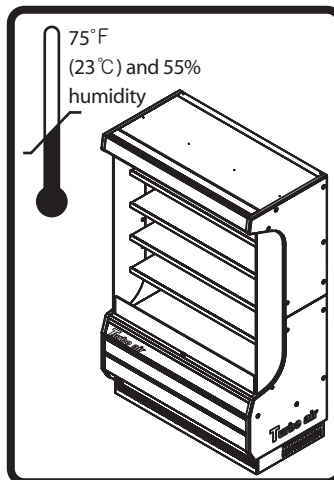

- Operating environment not to exceed 75°F (23°C) and 55% humidity.

- Do not load product beyond the edge of the shelf

## OPERATING INSTRUCTIONS

Level and set your merchandiser in place. Connect all necessary electrical connections. Your Open Display Merchandiser should now be ready for use.





### **TOM-\*\*L, TOM-\*\*S**

- **POWER SWITCH:**  
Located at the bottom of front panel right, colored in red.
- **LIGHT SWITCH:**  
Located at the bottom of front panel right, colored in green.
- **TEMPERATURE CONTROL:**  
Located at the bottom of front panel right.



### **TOM-W-\*\*S**

- **POWER SWITCH:**  
Located at the bottom of rear panel right, colored in red.
- **LIGHT SWITCH:**  
Located at the bottom of rear panel right, colored in green.
- **TEMPERATURE CONTROL:**  
Located at the bottom of rear panel right.

### **HOW TO SET THE TEMPERATURE**

1. Press the SET button  for 1S to check the temperature setting.
2. The display panel shows the current temperature setting.
3. To change the temperature, press the UP  or DOWN  button and  press the SET button when adjustment is complete.
4. The temperature setting has been changed and the display panel shows the current temperature.

### **MANUAL DEFROST**

1. Press the DEFROST button  for 3S to begin a manual defrost.
2. Defrost mode will be off automatically when it is complete
3. During the defrosting process, pressing the DEFROST button  for 3S will stop defrosting and turn off the defrost mode.

### **THERMOMETER**

Thermometer showing temperature is located on the right side of the back panel.

#### **NOTE:**

- Do not place products into your merchandiser until the desired temperature is reached.
- Do not place hot products into the merchandiser.

### **PRODUCT PLACEMENT:**

Overloading of product or placing products against the back wall or suction grill may cause disruption in air flow, which may cause the unit to not cool properly.

## MAINTENANCE & CLEANING

Always turn off your unit (both power and lights) when cleaning. Remove all products and allow your unit to reach room temperature. Do not allow electrical components to get wet.

### **CLEAN YOUR OPEN DISPLAY MERCHANDISER THOROUGHLY BEFORE FIRST USAGE.**

- a. Do not clean with harsh detergents. Use mild soap.
- b. Remove all products.
- c. Remove shelves and bottom trays.
- d. Clean interior with warm water and mild detergent.
- e. Wipe with damp cloth. Do not leave soap residue.

### **CLEANING THE CONDENSER COIL**

Condenser coil is located at bottom behind panel.

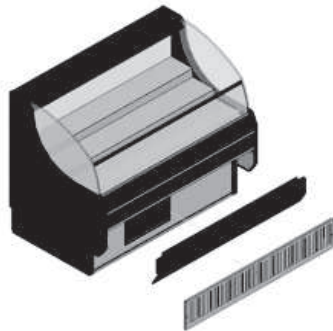

1. Disconnect the electrical power from the unit.
2. Remove the front cover and base cover with screw driver.
3. Brush the dirt, lint, etc. from the finned condenser coil.
4. When finished, be sure to replace the front cover and base cover.
5. Reconnect the electrical power to the unit.

**NOTE:**

For a self-cleaning condenser equipped model, condenser cleaning is not required.

However, it is recommended to blow the condenser coil out with Nitrogen once or twice a year. Note that the condenser cleaner may not remove grease.

## TROUBLESHOOTING

For any problems with your unit, please refer to the following check list. If you are still experiencing problems or have questions, please call the Customer Service line at 1-800-381-7770.

### **I . MERCHANDISER NOT FUNCTIONING**

- a. Check to see that the breaker hasn't tripped.
- b. Check that enough power is BEING supplied to the unit.
- c. Check that the power switch is on.

### **II . MERCHANDISER IS WARM**

- a. Check the condenser to see if it is clean.
- b. Check that the inner airflow is not being blocked by products.

### **III . LIGHTS ARE NOT WORKING**

- a. Check that light switch is on.
- b. Check that the lights are placed in the lamp holders correctly.



## WARRANTY INFORMATION

### **TWO (2) YEAR WARRANTY**

#### **Warranty Claims...**

All claims for parts or labor must be made directly through Turbo Air. All claims should include: model number of the unit, the serial number of the cabinet, proof of purchase, date of installation, and all pertinent information supporting the alleged defect. In case of compressor replacement under warranty, either compressor or compressor tag must be returned to Turbo Air along with above listed information. Failure to comply with warranty policies will result in voiding claims.

#### **Two-Year Parts & Labor Warranty...**

Turbo Air warrants all new refrigerated components, the cabinet and all parts, to be free from defects in materials or workmanship, under normal and proper use and maintenance service as specified by Turbo Air and upon proper installation\* (indoor building only) and start-up in accordance with the instruction packet supplied with each Turbo air unit. Turbo Air's obligation under this warranty is limited to a period of two (2) years from the date of original installation or twenty seven (27) months after shipment date from Turbo Air, whichever occurs first. Any part covered under this warranty, that is by Turbo Air to have been found defective within two (2) years of original installation or twenty seven (27) months after shipment date from manufacturer, whichever occurs first, is limited to the repair or replacement, including labor charges, of defective parts or assemblies. The labor warranty shall include standard straight time labor charges only and reasonable travel time, as determined by Turbo Air. (\*Installation in unstable, mobile, and enclosed area may not be considered as proper installation.)

#### **Additional Three-Year Compressor Warranty...**

In addition to the two (2) year warranty stated above, Turbo Air warrants its hermetically sealed compressor to be free from defects in both material and workmanship under normal and proper use and maintenance service for a period of three (3) additional years from the date of original installation, but not to exceed five (5) years and three(3) months after shipment from the manufacturer. Compressor determined by Turbo Air to have been defective within this extended period will, at Turbo Air's discretion, be either repaired or replaced with a compressor or compressor parts of similar design and capacity.

The three (3) year extended compressor warranty applies only to hermetically sealed parts of the compressor and does not apply to any other parts or components, including, but not limited to, cabinet, paint finish, temperature control, refrigerant, metering device, driers, motor starting equipment, fan assembly and/or other electrical components, etcetera.

#### **R-290/R-600a Hydrocarbon Compressor Warranty...**

The three-year compressor warranty detailed above will be void if the following procedure is not carefully adhered to:

1. This system may contain R290 refrigerant and polyol ester lubricant.  
The polyol ester lubricant has rapid moisture absorbing qualities. If long exposure to the ambient conditions occur, the lubricant must be removed and replaced with new.
2. Drier replacement is very important and must be changed when a system is opened for servicing.  
Drier with XH-7 molecular sieve or better must be used.
3. Micron level vacuums must be achieved to ensure low moisture levels in the system. 500 microns or lower must be maintained.
4. Compressor must be obtained through Turbo Air, unless otherwise specified in writing, through Turbo Air's warranty department.

## WARRANTY INFORMATION

### ***What is Not Covered by This Warranty...***

Turbo Air's sole obligation under this warranty is limited to either repair or replacement of parts, subject to the additional limitations below. This warranty neither assumes nor authorizes any person to assume obligations other than those expressly covered by this warranty.

**NO CONSEQUENTIAL DAMAGES. TURBO AIR IS NOT RESPONSIBLE FOR ECONOMIC LOSS; PROFIT LOSS; OR SPECIAL, INDIRECT, OR CONSEQUENTIAL DAMAGES, INCLUDING WITHOUT LIMITATION, LOSSES, OR DAMAGES ARISING FROM FOOD OR PRODUCT SPOILAGE REGARDLESS OF WHETHER OR NOT THEY RESULT FROM REFRIGERATION FAILURE.**

**WARRANTY IS NOT TRANSFERABLE.** This warranty is not assignable and applies only in favor of the original purchaser/user to whom delivered. ANY SUCH ASSIGNMENT OR TRANSFER SHALL VOID THE WARRANTIES HEREIN AND SHALL VOID ALL WARRANTIES, EXPRESS OR IMPLIED, INCLUDING ANY WARRANTY OF MERCHANTABILITY OR LABOR COVERAGE FOR COMPONENT FAILURE OR OTHER THE WARRANTY PACKET PROVIDED WITH THE UNIT.

Turbo Air will not be held responsible for the following external factors: ALTERATION, NEGLIGENCE, ABUSE, MISUSE, ACCIDENT, DAMAGE DURING TRANSIT OR INSTALLATION, FIRE, FLOOD, ACTS OF GOD, OR IMPROPER ELECTRICAL CONNECTIONS.

**TURBO AIR IS NOT RESPONSIBLE FOR THE REPAIR OR REPLACEMENT OF FAILED OR DAMAGED COMPONENTS RESULTING FROM ELECTRICAL POWER FAILURE, THE USE OF EXTENSION CORDS, LOW VOLTAGE, OR VOLTAGE DROPS TO THE UNIT.**

Use of NON-OEM parts without manufacturer's approval may void cabinet warranty.

**NO IMPLIED WARRANTY OF MERCHANTABILITY OR FITNESS FOR A PARTICULAR PURPOSE; THE FOREGOING WARRANTIES ARE EXCLUSIVE AND EXPRESSLY GIVEN IN LIEU OF ALL OTHER WARRANTIES, EXPRESSED, IMPLIED OR STATUTORY.**

**THERE ARE NO WARRANTIES, WHICH EXTEND BEYOND THE DESCRIPTION ON THE FACE HEREOF.**

Warranty information card must be submitted via post mail or electronically on our website at [www.turboairinc.com/registration](http://www.turboairinc.com/registration) within 7 days from the purchase date. Failure to comply may result in your warranty being voided.

All coverage provided within this warranty is applicable only to the United States, including Alaska and Hawaii, and Canada, excluding U.S. Territories; limited parts only warranty in U.S. Territories. Turbo Air is not responsible for any warranty claims made on products sold or used outside the fifty states of the United States.

The extended warranty period specific to each Turbo Air product applies to all units sold by Turbo Air starting December 1, 2016.







NOTE

Lined writing area for notes, consisting of 21 horizontal dashed lines.



Warranty information card must be submitted via post mail or electronically on our website at [www.turboairinc.com/registration](http://www.turboairinc.com/registration) within 7 days from the date of purchase. Failure to comply may result in your warranty being voided.

## WARRANTY REGISTRATION CARD



**MAIL CARD IMMEDIATELY OR GO TO ONLINE  
REGISTRATION AT [www.turboairinc.com/registration](http://www.turboairinc.com/registration)**

**Company Name:** \_\_\_\_\_

**Type of Business:** \_\_\_\_\_

**Model Number:** \_\_\_\_\_

**Serial Number:** \_\_\_\_\_

**Phone Number:** \_\_\_\_\_, **Email:** \_\_\_\_\_

**Address:** \_\_\_\_\_,  
(Street / Unit #)

\_\_\_\_\_, \_\_\_\_\_, \_\_\_\_\_  
(City) (State) (Zip Code)

I, \_\_\_\_\_ hereby inform and certify to Turbo Air Inc. (Manufacturer) that the product model  
(Owner's Name)

and serial number mentioned above was purchased on \_\_\_\_\_ from \_\_\_\_\_.  
(Date of Purchase) (Name of the Dealer)

**Turbo Air Inc.**

4184 E. Conant St., Long Beach, CA 90808

Toll Free: 1-800-381-7770

Fax: 310-900-1033

Email: [warranty@turboairinc.com](mailto:warranty@turboairinc.com)



REFRIGERATOR MANUFACTURER  
***Turbo air***

4184 E. Conant St., Long Beach, CA 90808

Toll Free: 1-800-381-7770

Fax: 310-900-1033

Email: [warranty@turboairinc.com](mailto:warranty@turboairinc.com)

**[www.turboairinc.com](http://www.turboairinc.com)**